

The image shows a large industrial machine, the SORTEX F BioVision optical sorter. It has a grey exterior with a control panel on the left side. The control panel features a color touchscreen displaying a software interface with a graph and various icons. Below the screen, the text 'SORTEX F BioVision' is printed. Underneath the text are five safety icons: a yellow warning triangle, a blue icon of a person wearing a hard hat, a blue icon of a person wearing safety glasses, a blue icon of a person wearing earplugs, and a yellow lightning bolt icon. The machine's interior is visible through a large opening on the right, showing a complex arrangement of metal components, including a conveyor system and various mechanical parts. The interior is partially obscured by a semi-transparent yellow and green overlay. The machine is supported by a sturdy metal frame with legs.

SORTEX F
BioVision



SORTEX® F **optical sorter.**

Safer and cleaner
nut and dried fruit
processing.

SORTEX® F optical sorter. For safer and cleaner nuts and dried fruit.



The industry's most hygienic optical sorter, enhanced for nut and dried fruit processors now available with the technology that has transformed the snack food industry – SORTEX BioVision™.

The SORTEX F, combined with SORTEX BioVision™ technology, offers nut and dried fruit processors 4-in-1 detection of colour defects, shell and foreign materials in just one optical sorting platform. The unique open design frame also lowers the risk of bacterial contamination thanks to its easy cleaning access, hygienic grade fixings and sloped surfaces.

The pioneering sorter can be configured for all areas of the nut and dried fruit processing industry, from primary to secondary processors including manufactures of snack nuts, nut spreads

and nut milks for a versatile solution which focuses on hygienic and efficient sorting, seamlessly, at all stages of the processing line.

- Hygienic open design with zero tolerance for contamination.
- Available with SORTEX BioVision™ technology for 4-in-1 colour, shell and foreign material detection.
- Detects hazardous materials up to 50% smaller than the current market standard.

SORTEX BioVision™ Specialist detection technology for nuts.

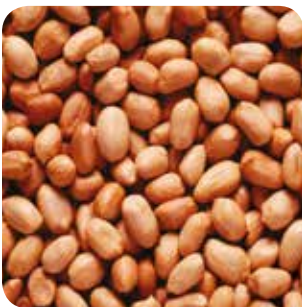

SORTEX® F optical sorter. At a glance.

1 Accessible, stainless steel frame

Every element from the stainless steel frame, sloped surfaces to the hygienic screws has been carefully selected with food safety in mind – leaving no detail untouched.

2 Anodized, adjustable chute

Available in 600mm and 1200mm the anodized chute provides an easy to clean surface for nut processing. Higher processing capacities with resort capabilities, the chutes are easily adjusted, allowing operators greater access inside the machine.

3 Unique open receptacle

Unique to Bühler, the receptacle can be easily opened and closed to give processors access for cleaning, reducing the risk of contamination. This receptacle is combined with a state-of-the-art dust extraction system creating the optimum working environment.

4 State-of-the-art detection system

Available with pioneering SORTEX BioVision™ technology – a unique configuration of detection technologies including BioCam™ combined with high definition InGaAs^{HD} or colour cameras, or both - for simultaneous detection of colour defects, shell and foreign materials.

5 LED XENON foreground lighting

Provides consistent broad-spectrum lighting across the view for more uniformity with less shadowing.





6 LED background

With red, green and blue backgrounds, processors can define the optimal sorting mode regardless of the product being sorted.

7 Larger, 17 inch user interface

Enhanced user interface features a larger screen and controls, simplifying usability for the operator.

8 SORTEX ProSortX™ operating software

New SORTEX ProSortX™ operating software comes as standard. Featuring a fresh new interface that is modern, clean and intuitive to use.

9 Smart Sorting capabilities

Featuring self-learning capabilities with pre-set and user-defined modes for click and forget sorting that minimises operator intervention.

10 Ultra-modern cooling system

Maintaining consistent temperatures across the entire sorting function, this integrated system enables consistent component performance and product quality.

SORTEX® F optical sorter technologies. Innovations and leadership.

From Competence Centres around the world and optical sorting headquarter in London, our researchers, engineers and product developers work in partnership with our customers to develop proprietary technologies that are at the forefront of the optical sorting industry - since 1947.

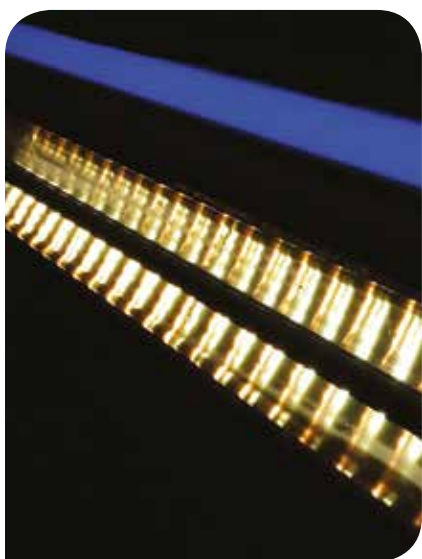

Sophisticated LED lighting.

Sophisticated LED-Xenon foreground lighting provides the ultimate broad-spectrum lighting for greater uniformity with less shadowing whilst new LED background lighting comes with red, green or blue options to ensure optimal sorting performance is achieved, no matter the application being sorted.

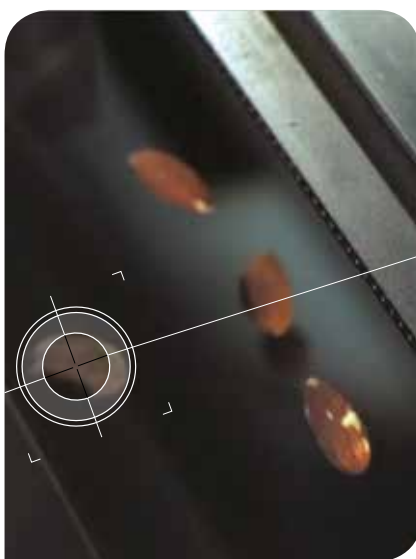

Intelligent ejector technology.

SmartEject™ - high speed, high flow ejectors efficiently remove defects with pinpoint precision and accuracy.

Ejector+ technology, Bühler's most powerful ejectors are available as an option on SORTEX F optical sorters to remove heavier objects such as stones and glass.



SORTEX® ProSortX™ operating software

The latest update of Bühler's proprietary operating software comes with a fresh new interface that's modern, clean and intuitive to use. Featuring innovative FingerTipControl™ and all-new Bühler ATOM™ board for faster processing and navigation between screens.

SORTEX® F optical sorter.
Safety, hygiene, design and performance.



1200mm chute

Designed with hygiene and food safety in mind.



Technology feature **SORTEX BioVision™**



BioVision™ is a suite of technology available only on Bühler SORTEX optical sorters. A combination of high definition infrared, shape technology and biochromatic colour detection.

With increased requirements for food safety and hygiene to meet customer expectations BioVision™ technology is a unique toolkit for superior nut quality delivering your cleanest, safest product yet.

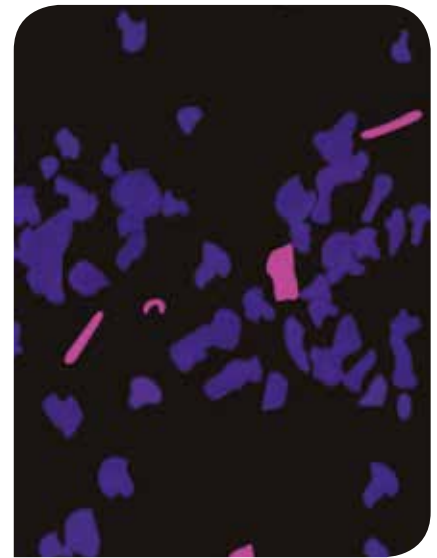

SORTEX® BioCam™

The advanced SORTEX BioVision™ detection system is a unique configuration of detection technologies which includes BioCam™ combined with high definition InGaAs^{HD}, colour cameras and PROfile™ technology.

Innovative BioCam™ technology targets the spectral and spatial differences between the good product and shell, new high-definition InGaAs^{HD} cameras detect foreign materials in the near invisible infrared spectrum and custom-built visible cameras remove colour defects including dark, rotten, yellow and spot defects.

High definition InGaAs^{HD} technology

The next generation infrared detection technology from Bühler now comes in high definition with double the resolution to detect foreign materials down to half the size. With twice as many pixels, InGaAs^{HD} detects the smallest pieces of hazardous materials that cannot be seen in the visible spectrum for an added layer of assurance.

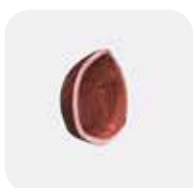

Hard Shell

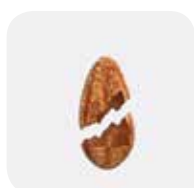

Soft Shell

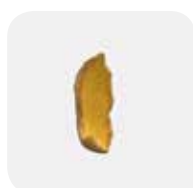

Hull

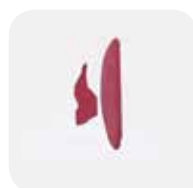

Plastic

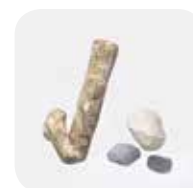

Sticks and Stones

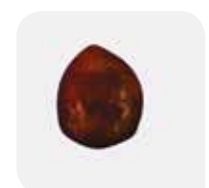

Rotten & insect bitten produce

Colour, shell and foreign material detection - all in one.

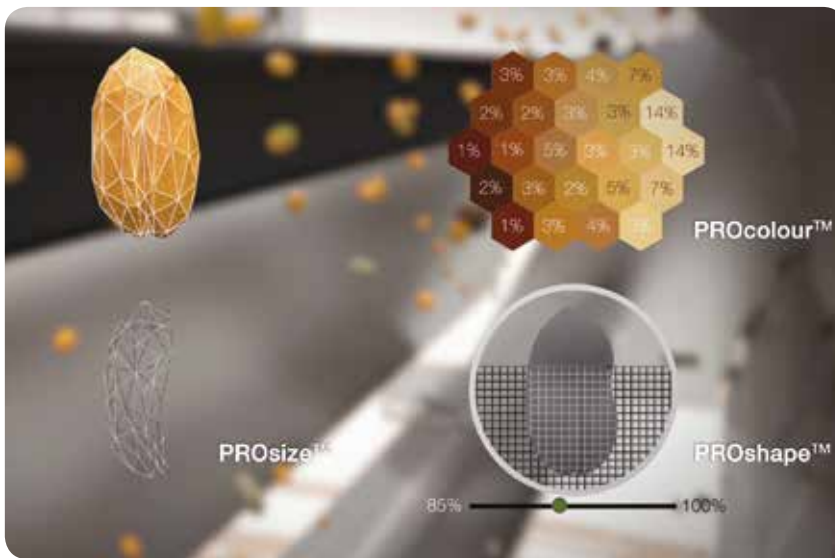

SORTEX® PROfile™ technology

A combination of three dynamic technologies which enable Bühler optical sorters to perform even the most complex sorting tasks. Designed with multiple levels of shape, size and colour detection to deliver consistent, uniform product quality at the highest capacity possible. This unique double detection system analyses produce from both sides to offer processors total quality assurance.

PROsize™

Far advanced from traditional grading solutions, PROsize™ can be employed in situations where product is too delicate or difficult to be sorted using conventional mechanical graders, maximising profitability by distinguishing the premium product.

PROcolour™

Processors can define the maximum percentage of surface blemish based on retail or customer specifications, enabling them to grade products on their physical appearance and maximise commodity value by defining multiple grades of quality product.

PROshape™

PROshape™ is an intelligent detection technology which inspects product based on shape criteria when the defective product is the same colour as good product.

Model Variants and Specifications.

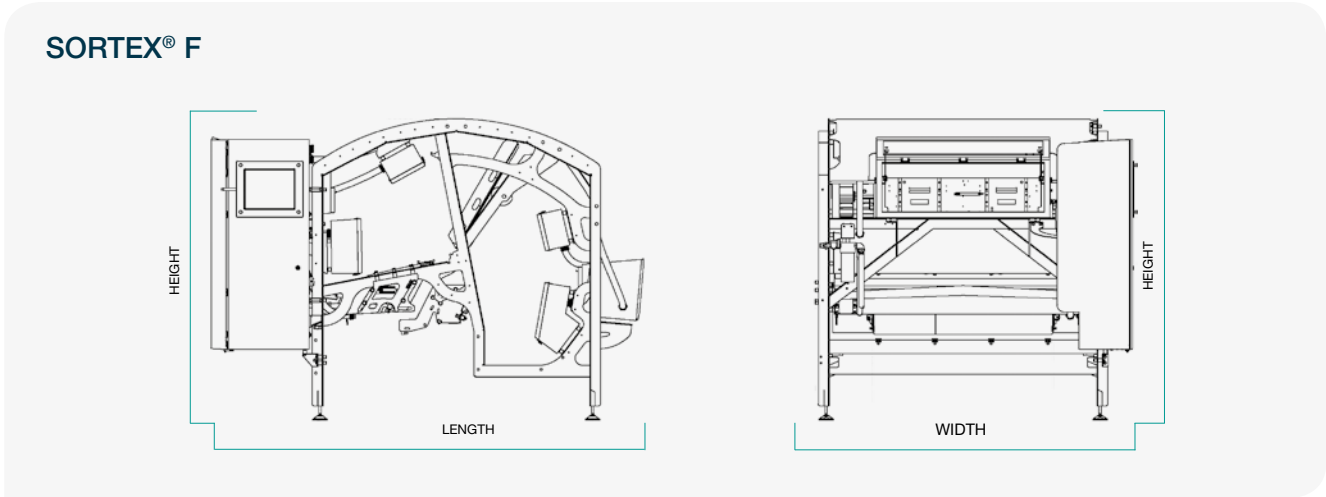

Product options

Features and Specifications	SORTEX F® BioVision™	SORTEX® F
SORTEX BioVision™	■	
Ejector+	●	●
Colour Cameras	■	■
InGaAs ^{HD}	■	●
PROfile™ technology	■	■
LED Background lighting	■	■
LED-Xenon lighting	■	■
Remote access	●	●
SORTEX ProSortX™	■	■
TotalCare Performance Protection	●	●

For the full feature list and product specifications contact your local representative.

■ Standard ● Optional

Dimensions, air and power requirements

SORTEX® F Range	Chute size mm	Width mm	Length mm	Height mm	Weight* kg	Typical air requirements (l/s)* 102-116 psi (7-8 bar)	Typical Power consumption (kW)** (200-240 V; 50/60 Hz single phase)
SORTEX FB1	600	1610	3010	2112	850	Standard 32 Ejector+ 45	2.4
SORTEX FB2	1200	2210	3004	2112	1250	Standard 65 Ejector+ 90	4.75

SORTEX® Customer Care.

Secure tomorrow's profits today.

Bühler customers have access to a network of over 140 sales and service offices worldwide offering customisable service packages, stock on spares and upgrade kits, to ensure your optical sorters perform at maximum possible efficiency. Training courses and competence centres offering application and product trials are also available at regional sites and local offices around the world.

TotalCare™

Create a customised service package, composed of individual service features from the list below. From maintenance visits, downtime cover to refurbishments and preventative - basic to fully comprehensive. Designed to ensure your optical sorters perform at its maximum performance.

TotalCare Protect

Minimise Downtime

Based on an agreed number of annual visits, Bühler engineers will replace key wear parts, provide consultation and advise on future maintenance requirements.

TotalCare Perform

Performance Optimisation

Aspiring to keep downtime to under 24 hours, sorters will be safeguarded against any failed components. Bühler engineers will ensure first-rate performance once the repair is carried out.

TotalCare PerformPLUS

Ejector Refurbishment

Making certain that sorters are running at peak performance, ejectors are replaced when the stipulated life-cycle is reached. Performance is maintained for the future.

TotalCare Anyware

Supervised Functionality

Provides a working record of operational information as well as reports that enable machine health to be monitored and preventative maintenance scheduled.

TotalCare AnywarePRO

Remote Access and Assistance

Sorter performance can be viewed remotely by customers and Bühler engineers. Faults can be diagnosed and performance optimised in any location using a laptop, tablet or smart phone.

All contract options are available for variable durations.

SORTEX® Spare Parts Promise

Customer satisfaction is our priority. This is why we strive to deliver both spare and wear parts within 48 hours - maximising your profitability.

SORTEX® Upgrade Kits

Bühler have designed various upgrade kits, for existing customers who are seeking to upgrade sorters with an additional module, new technology features or processing software.

SORTEX® Spare Parts

Various kits to suit different optical sorters are available for customers who wish to have spare parts available on site.

Optical Sorting Training Courses

Available from various regional Bühler locations. From operator to management, basic to advance, speak to your local representative for course selection and availability.

© The Bühler Group 2018

SORTEX® is an internationally registered
trademark of the Bühler Group

Bühler AG

Gupfenstrasse 5
9240 Uzwil
Switzerland
T +41 (0)71 955 11 11
F +41 (0)71 955 33 79

Business Unit SORTEX®

20 Atlantis Avenue
London E16 2BF
United Kingdom
T +44 (0)20 7055 7777
F +44 (0)20 7055 7700
sortexsales@buhlergroup.com
www.buhlergroup.com/sortexf-biovision

SO 31653 en 0418 Z&B 180305